

Note: VDD_PADS powers the internal PIO of the module

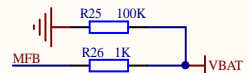

Power on boot

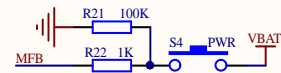

Button boot

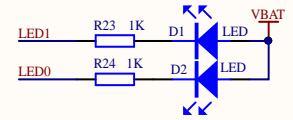

LED : led0 red , led1 blue

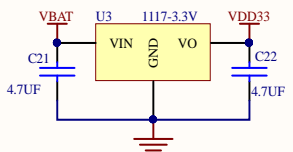

VBAT voltage : 3.3-4.2V

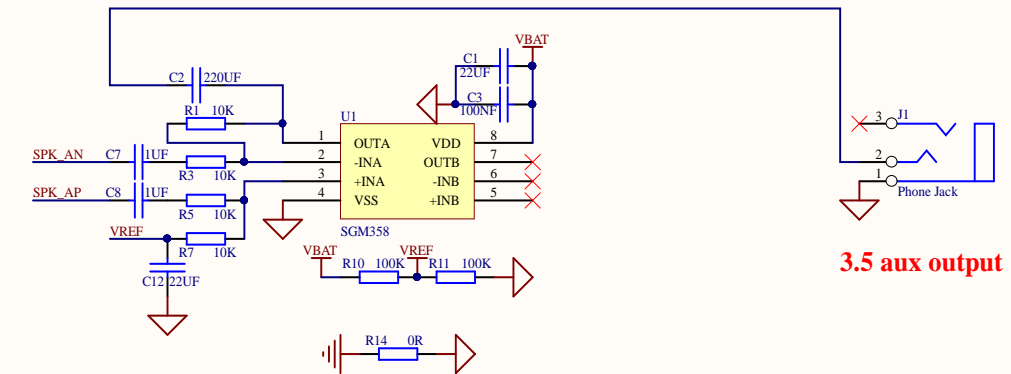

Differential to single-ended analog audio output

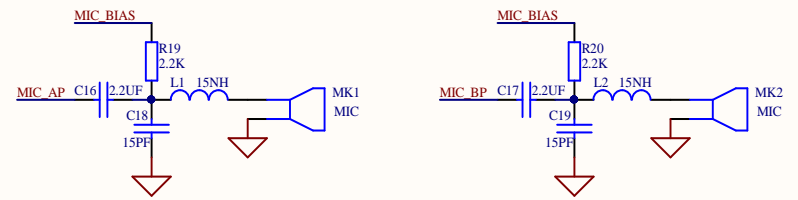

microphone input

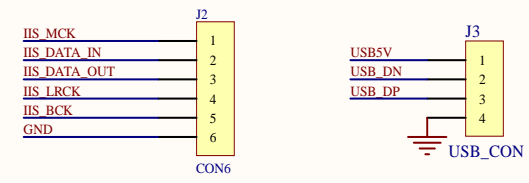

I2S Digital audio output

Title		
Size	Number	Revision
A4		
Date:	2023-01-23	Sheet of
File:	E:\OneDrive\BTM371.Sch	Drawn By: